

one

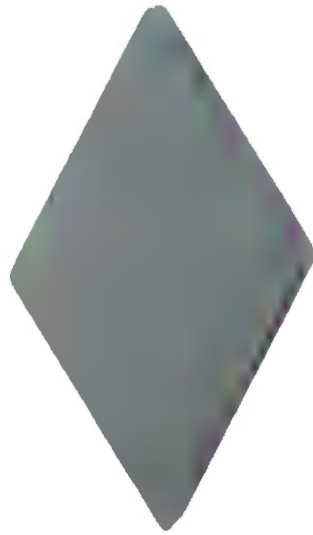

two

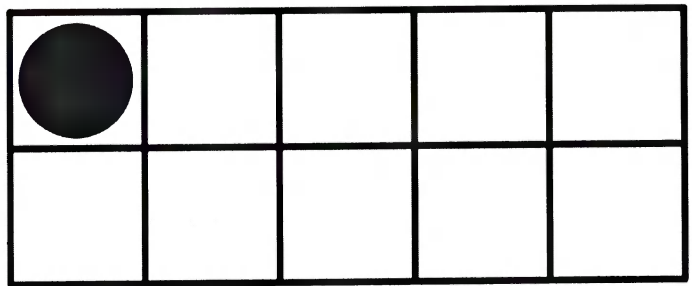
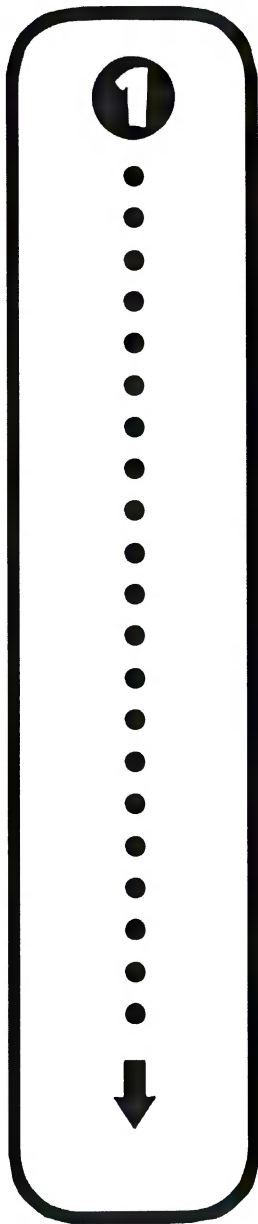
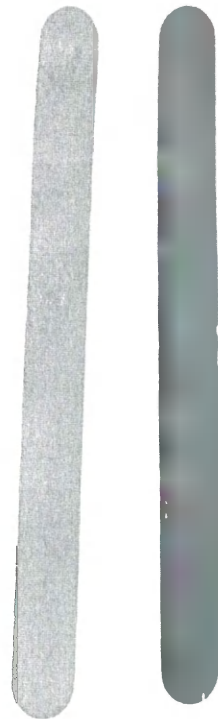
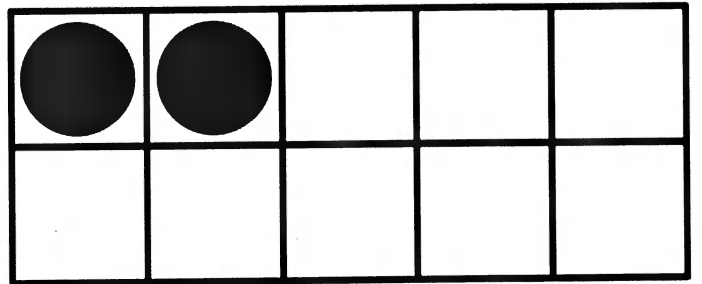

three

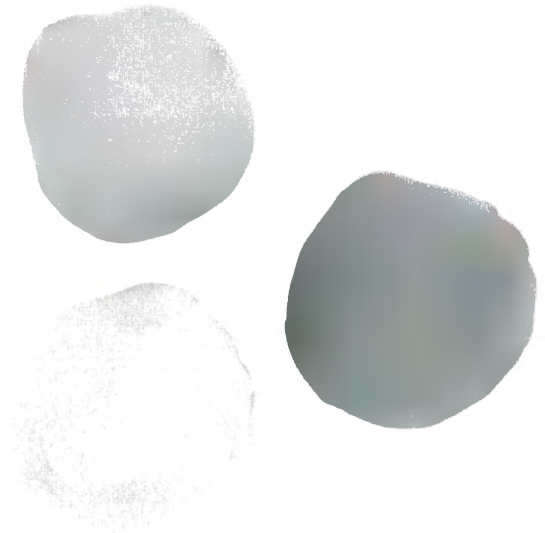
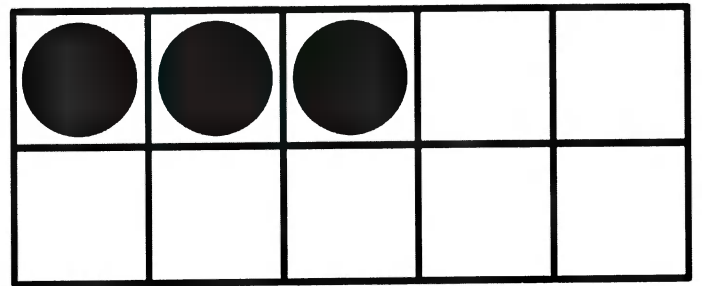
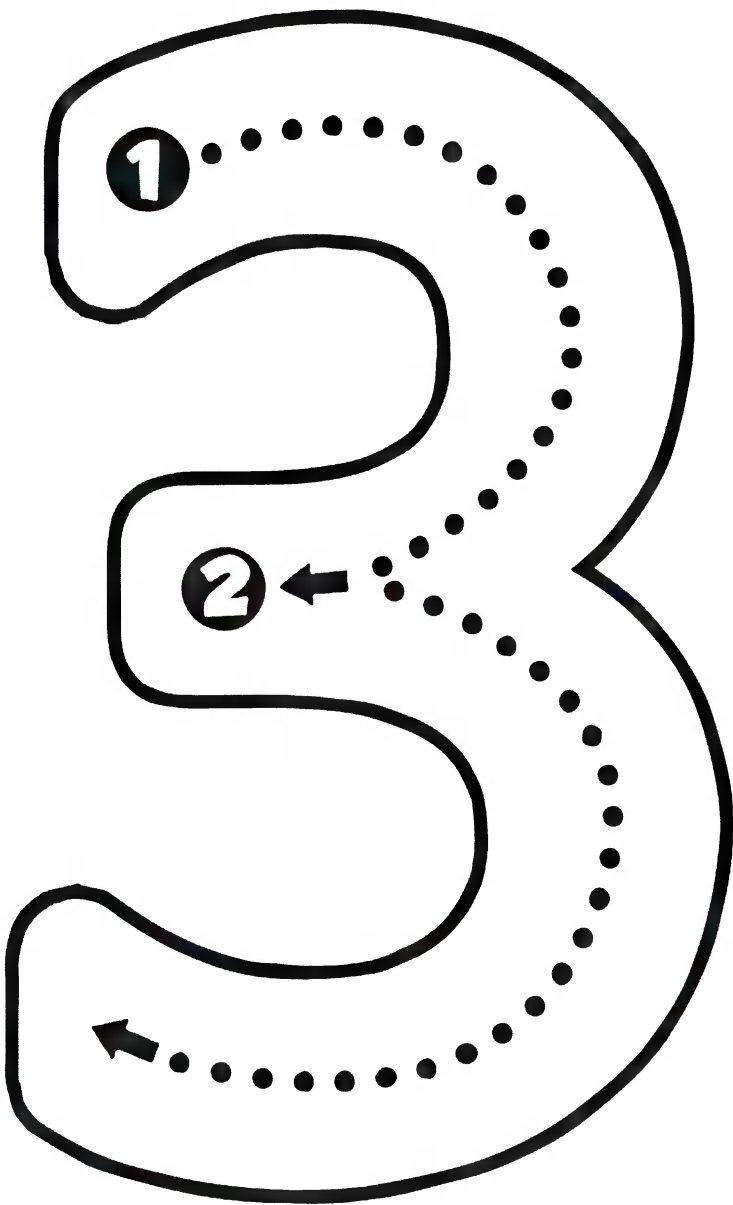

four

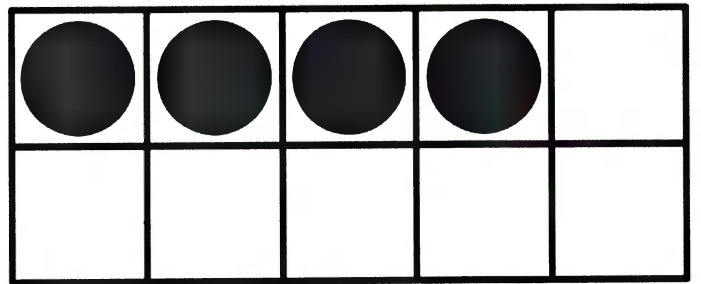
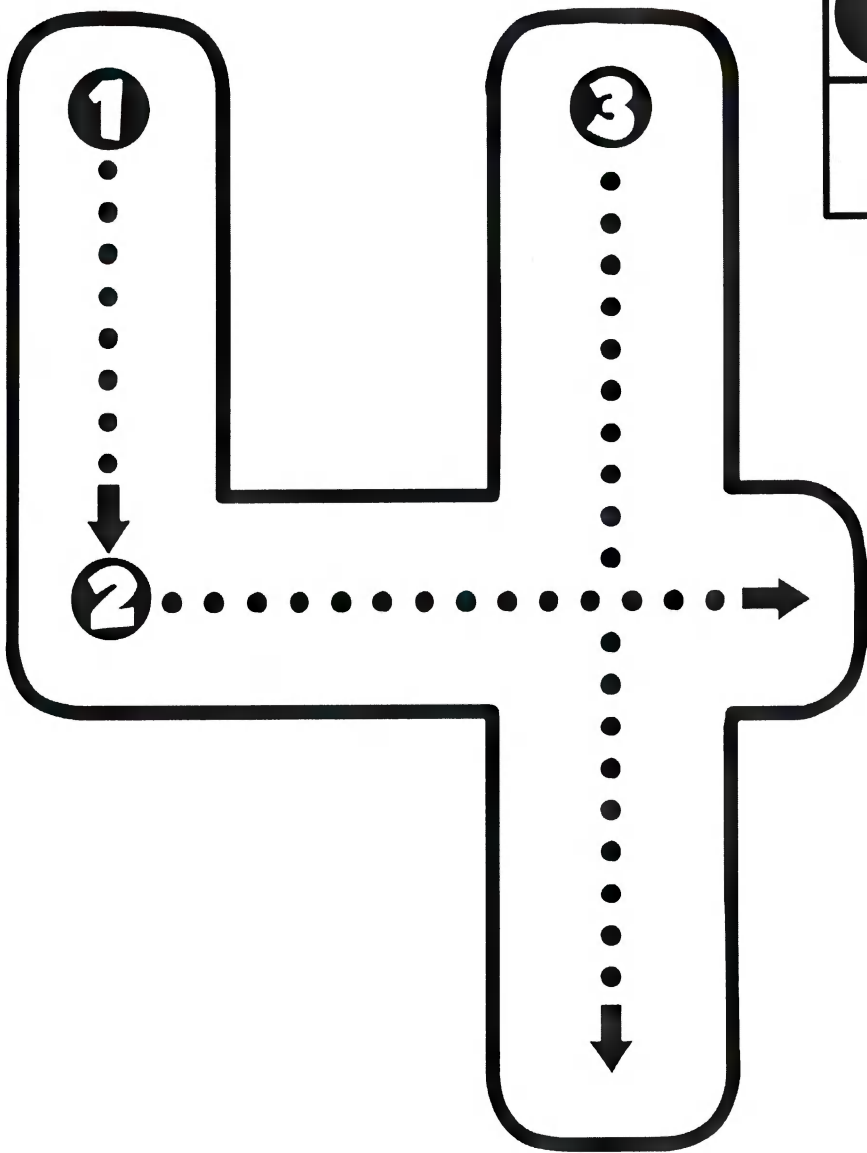

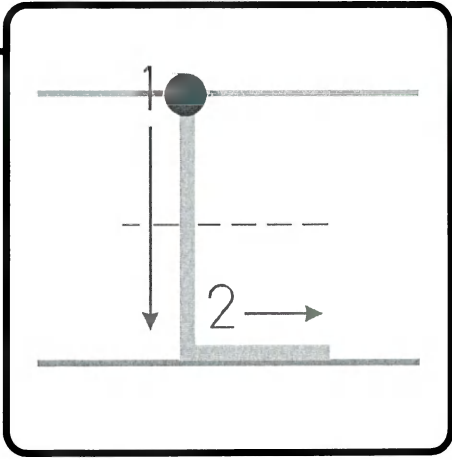

Name _____

Lester is a librarian.

L L L L

L L L L

L L L L

L L L L

L L L L

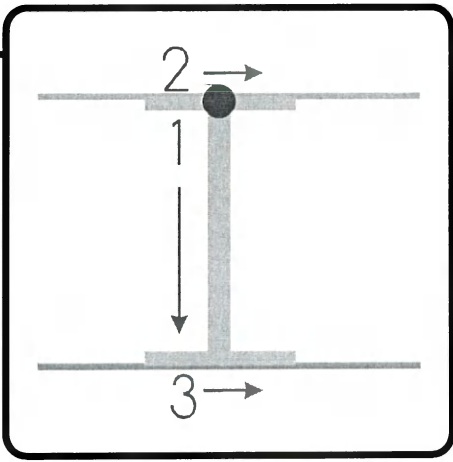

Name _____

Isaac is an inspector.

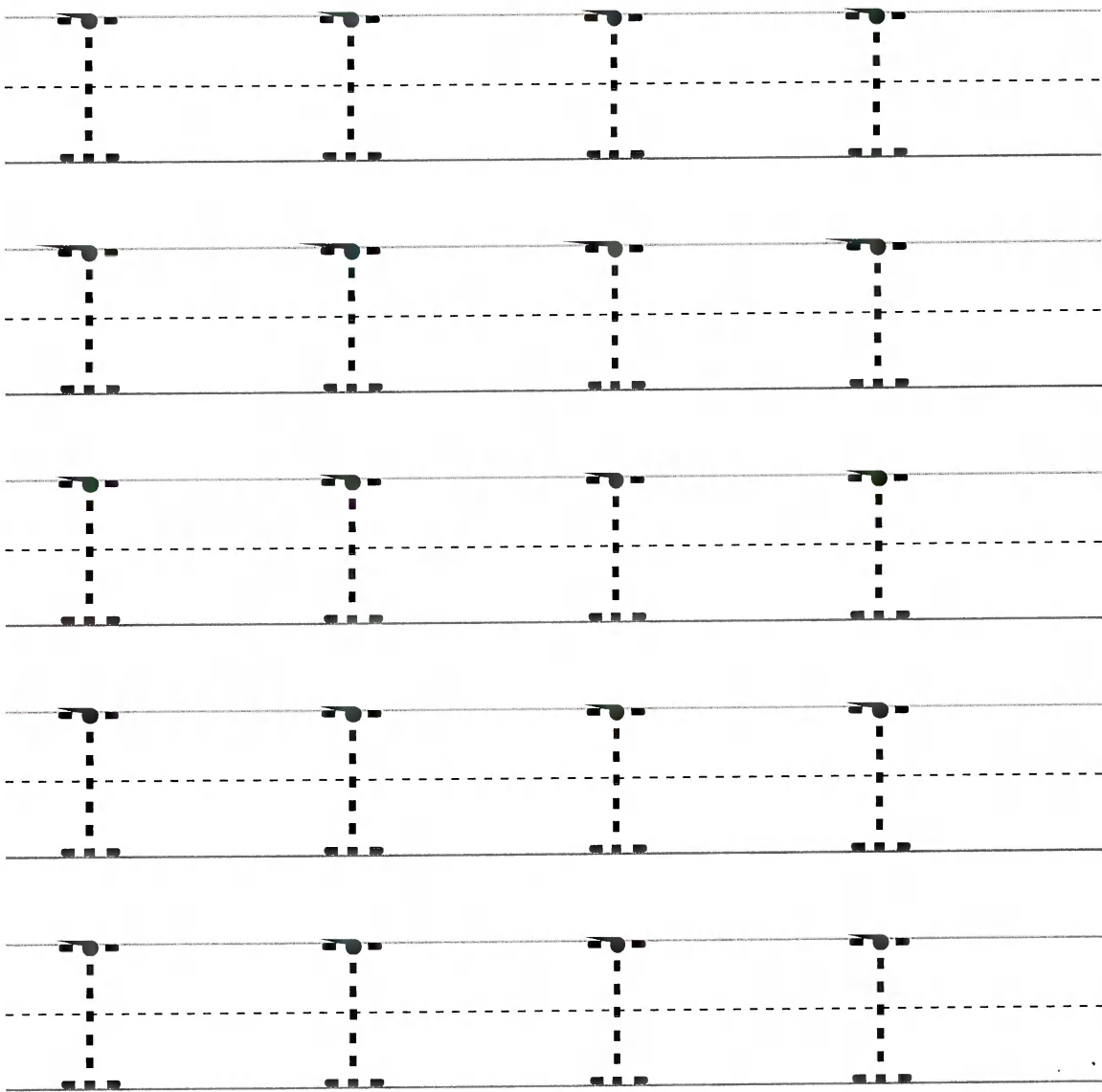

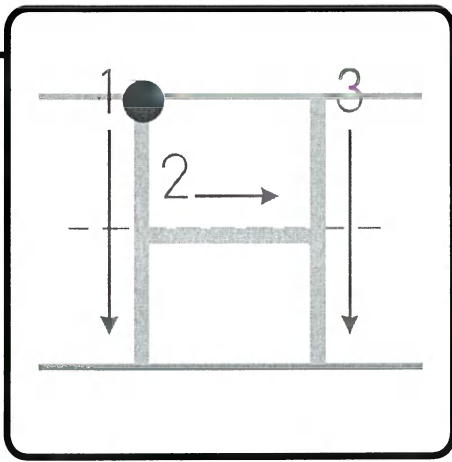

Name _____

Hatty is a hairdresser.

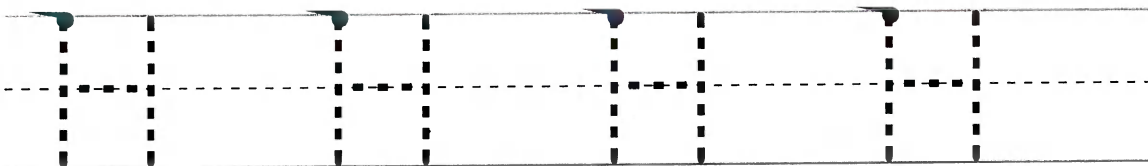
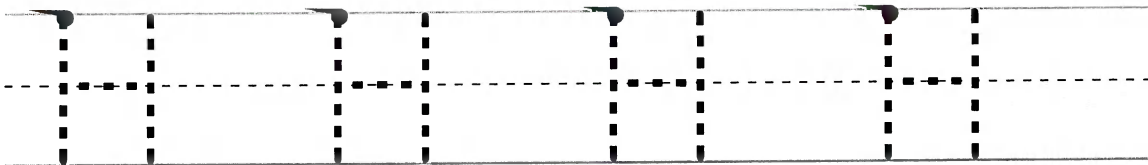
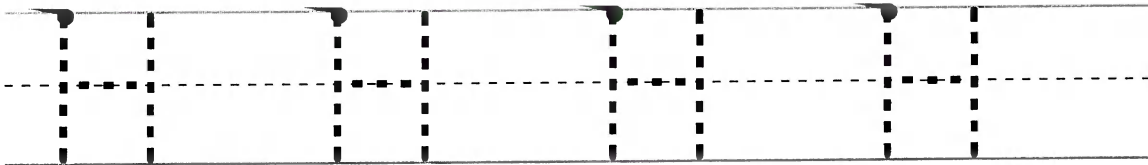
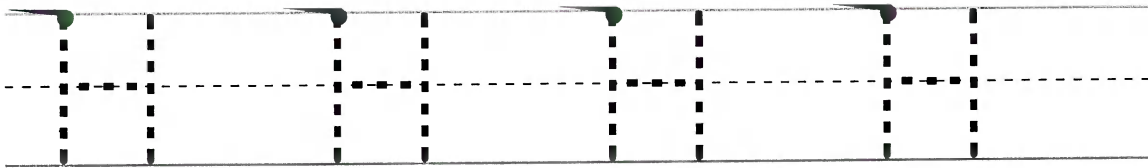
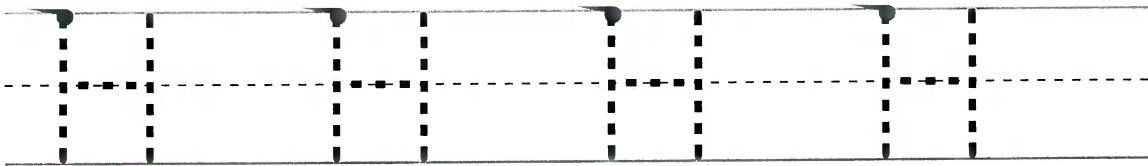

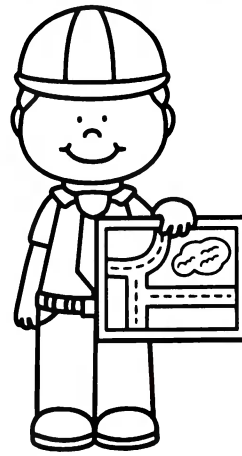
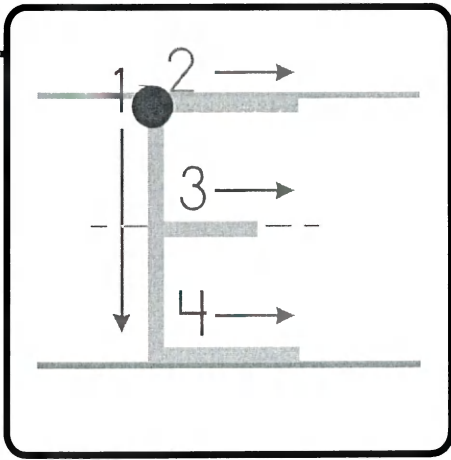

Name _____

Eddy is an engineer.

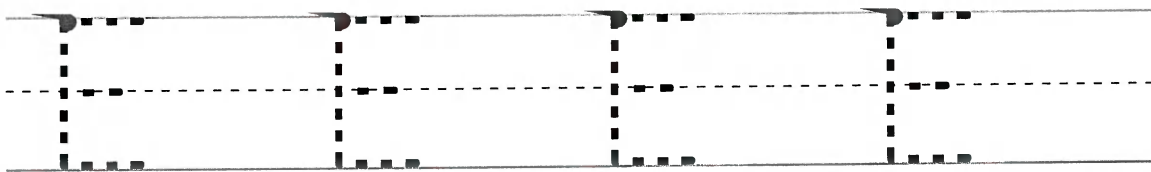
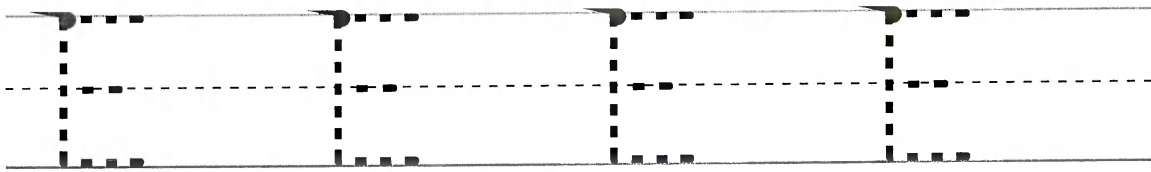
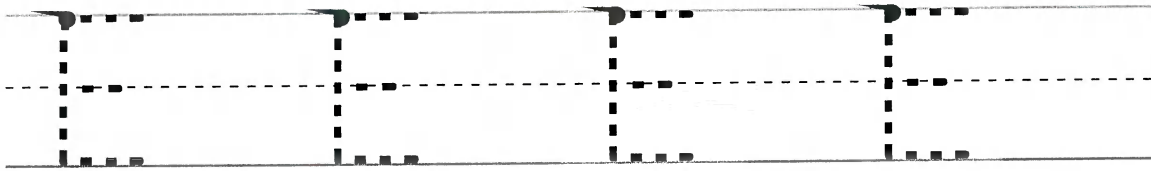
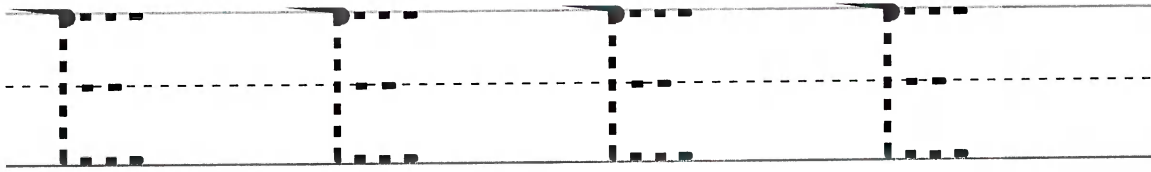
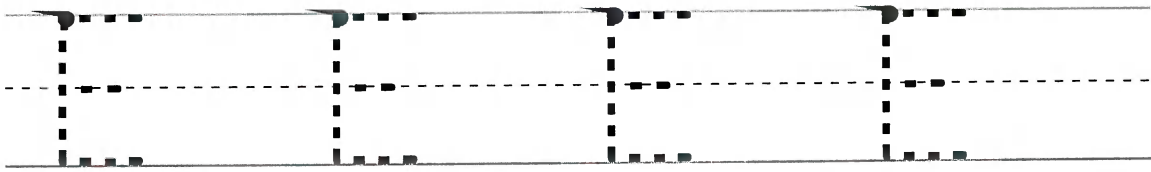

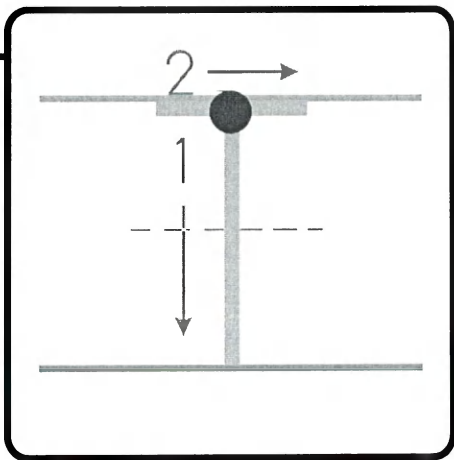

Name _____

Tim is a teacher.

Handwriting practice lines for the letter T. Each row consists of a solid top line, a dashed middle line, and a solid bottom line. The first row is a blank line. The following five rows each contain four dashed uppercase 'T's for tracing, each with a solid dot at the top left of the vertical stroke.

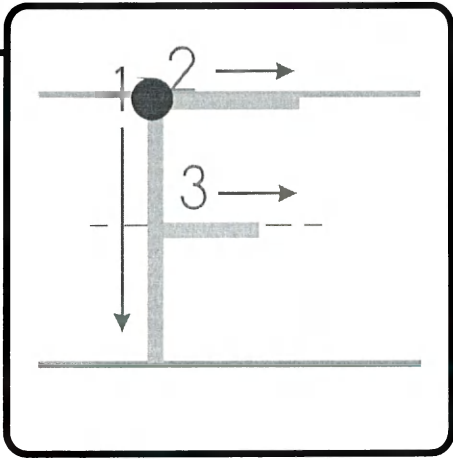

Name _____

Fred is a firefighter.

Handwriting practice lines for the letter 'F'. Each row consists of a solid top line, a dashed middle line, and a solid bottom line. The first row contains four dashed uppercase 'F's for tracing. The following five rows each contain four blank spaces for independent practice of writing the letter 'F'.

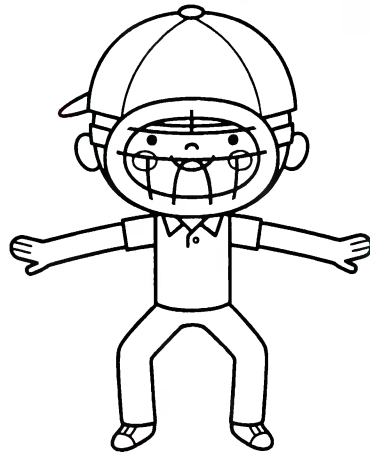
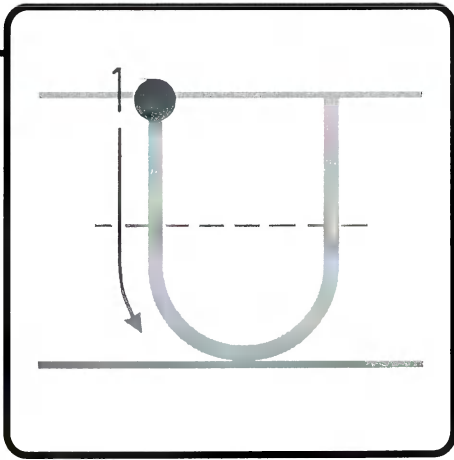

Name _____

Ultimo is an umpire.

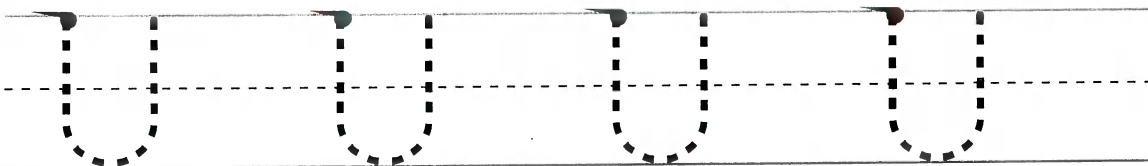
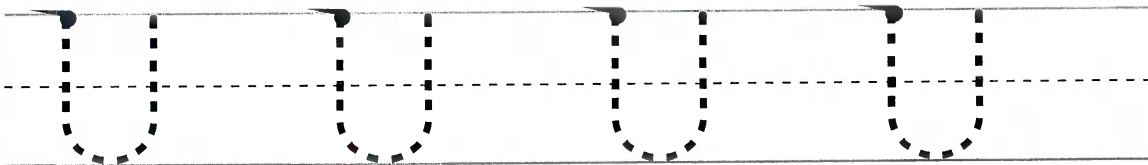
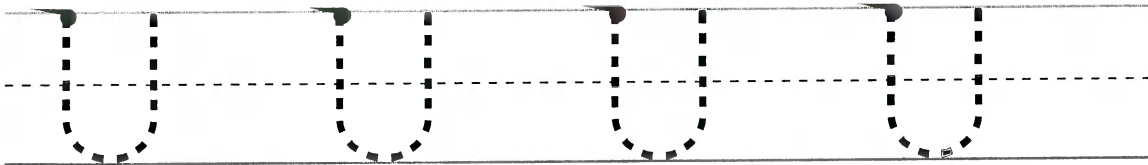
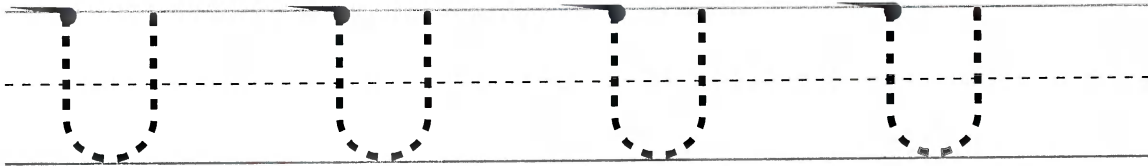
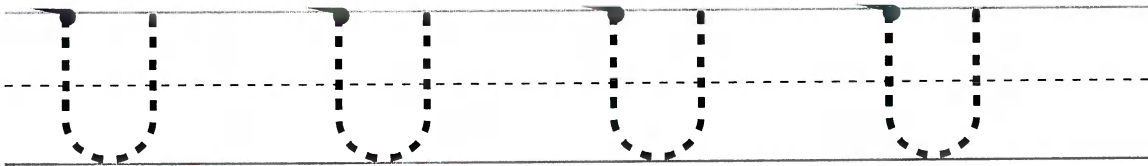

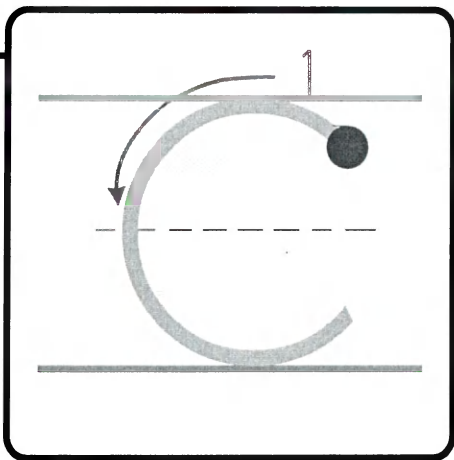

Name _____

Chris is a cashier.

